

INSTALLATION INSTRUCTIONS

Item#P1404-613 (New. 03/12/2015)

READ AND SAVE THESE INSTRUCTIONS

WARNING! SHUT POWER OFF AT FUSE OR CIRCUIT BREAKER.

AVERTISSEMENT! COUPER LE COURANT AU NIVEAU DES FUSIBLES OU DU DISJONCTEUR.

PREPARATION (Fig. 1)

1. Shut off the power at the fuse box or circuit breaker. If necessary, remove old fixture, including mounting hardware.
2. Carefully remove the fixture from the carton and check that all parts are included as shown in the illustration.

ASSEMBLING THE FIXTURE WITH BALL SWIVEL (Fig. 2)

3. Attach the mounting plate (A) to the junction box using mounting screws (B) (Size: #8-32N*L0.5").
4. Determine the desired hanging height and thread rods (F1, F2, and F3) to the nipple (J) of the fixture body (G). Pass the wires carefully through each rod as you assemble.
5. Place the canopy (C) over rods (F) and thread the hanger ball (E) to rods (F). Please remove the nipple if installing with one 6" rod only.
6. Install the fixture body into the mounting plate (A) by tilting at a slight angle so that the hanger ball (E) slips into the mounting plate (A) as shown. Align the notch in the hanger ball (E) to the tab on the mounting plate (A) to prevent the fixture from turning.

CONNECTING THE WIRES (Fig. 3)

7. At this point, connect the electrical wires as shown in figure 3, making sure that all wire connectors are secured. If your outlet has a ground wire (green or bare copper), connect the ground wires from the hanger ball and mounting plate to it. Otherwise, connect the ground wire from the hanger ball directly to the mounting plate ground wire and secure with the wire connectors provided. After wires are connected, tuck them carefully into the ceiling junction box.

COMPLETING THE INSTALLATION (Fig. 1)

8. Align the canopy (C) over the mounting plate (A) and secure with screws (D).
9. Install the light bulb(s) (not included) in accordance with the fixture's specifications. **(DO NOT EXCEED THE MAXIMUM WATTAGE RATING!) (NE PAS DEPASSER LA PUISSANCE NOMINALE MAXIMALE!).**

Your installation is now complete. Return power to the junction box and test the fixture.

Note: Illustration (Fig. 1) on this manual is for installation purposes only. It may or may not be identical to the fixture purchased.

Fig. 1

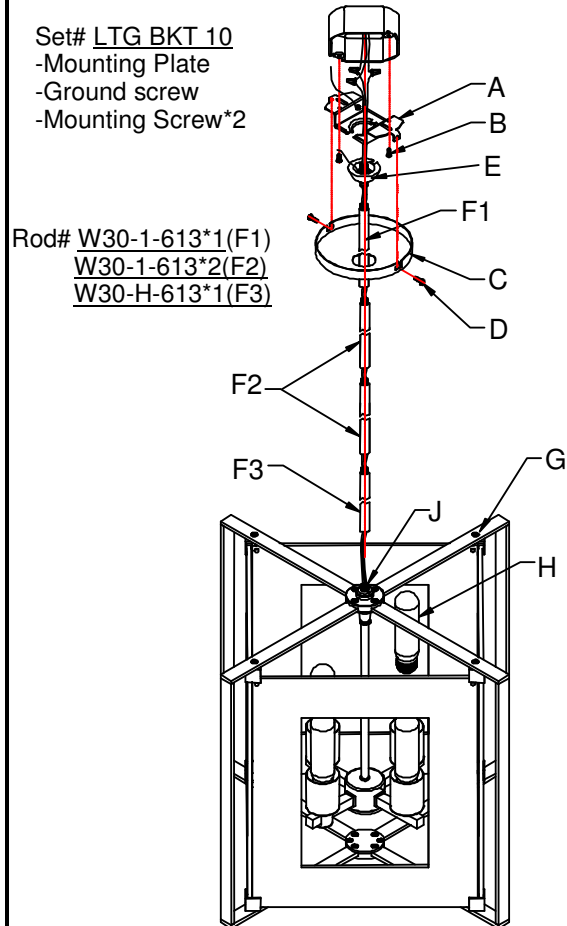

Fig. 3

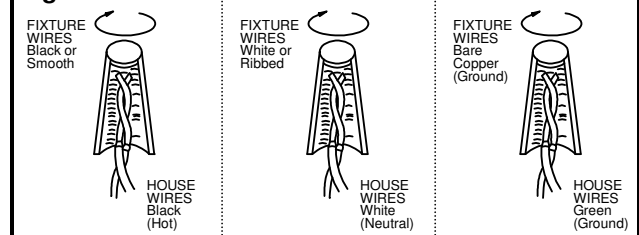
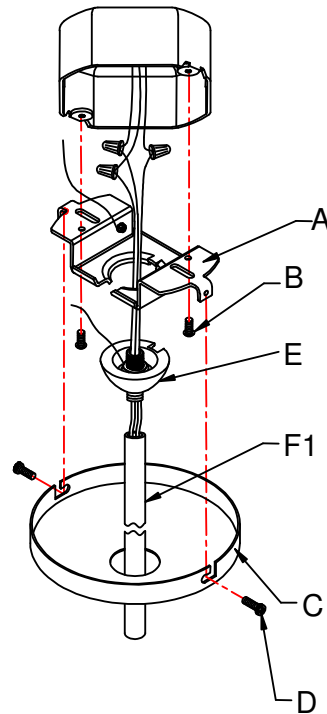
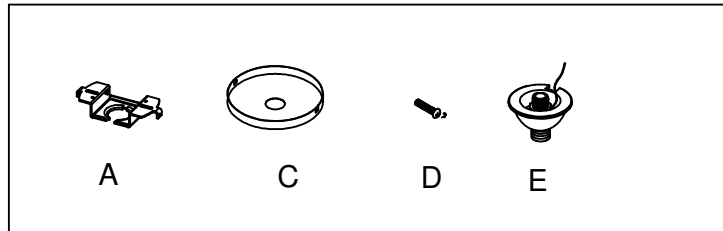

Fig.2



a. Hardware Bag:

- A. Mounting Plate*1
- C. Canopy*1
- D. Screw*2
- E. Hanger Ball*1



b. Hardware Bag:

- F1. ROD 12"*1
- F2. ROD 12"*2
- F3. ROD 6"*1

