

Installation manual for:

3100D30C

Dimensions:D30" H10" L6

Collection:chorus

Bulb Type:E12 bulb not included

Lamp Frame Weight(lbs):13

Total Weight(lbs):20



Thank you for choosing our product(s).

Our Company is actively involved in every step of the production.

Our product(s) are designed to be utilized for every application that graces your home or business.

We pride ourselves in providing the most prompt and courtesy service to all of the valued customers.

Please find the enclosed detailed instruction and read carefully for proper installation.

If you have any questions, our professional customer service team is committed to assisting you, please call our toll free HOTLINE AT:

1-888-388-3390



SAFETY

Warning: MAKE SURE THE ELECTRICITY TO THE WIRES YOU ARE WORKING ON IS SHUT OFF. BY EITHER REMOVING THE FUSE OR TURNING OFF THE CIRCUIT BREAKER.

CAUTION

- Before assembling the lighting fixture, please read all instructions carefully.
- All frame & crystal components are fragile, please handle with care.
- Required supply circuit : 110 - 130V/60Hz
- Labeled wires are "L" for live wire, "N" for neutral wire, "E" for ground wire.
- Never install fixture on damp ceiling, the room should be dry and well ventilated
- All electrical components must be installed by a licensed electrician and in accordance with the National Electrical Code and the appropriate local electrical codes.

Unpack the Package

Please open the box carefully and check all the items are inside the box. If you have any installation, assembling and missing parts questions, please call our Customer Service department at 1-888-388-3390. Please have model number(at the front page), where you purchase from and any other relevant information ready, our customer service team will provide comprehensive and worry free service to our valued customers.

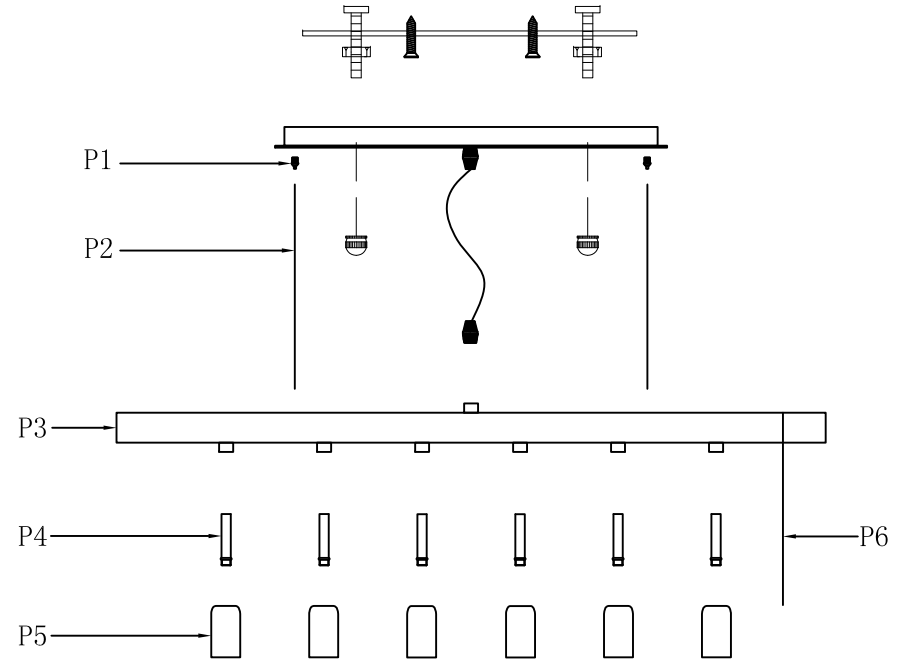
Frame Parts List







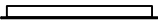

3100D30 D30"H10" L6

Step 1

Please use the parts list to ensure you are not missing any parts

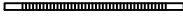

3100D30

PARTS LIST

part	picture	Description	Parts Number	Qty	Check list
ZA		Mounting Bracket	CP103100L16C	1	
ZB		16"Metal ceiling plate		1	
ZC		Knurled nut		2	
ZD		Power cord 10' Clear		1	
P1		Cable adjustment bolt		2	
P2		8.2' steel wire		2	
P3		30"Metal Pole		1	
P4		2"Both end threaded pipe		6	
P5		E12 Metal Lamp Cup		6	
P6		15.3" steel wire		30	
A		1050-14#*505-2.5" Steel wire 15.4"	1		

03

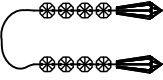
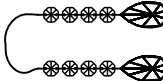
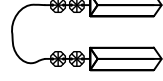
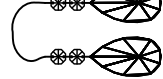
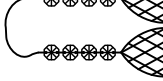
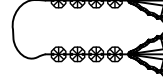
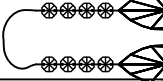
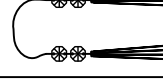
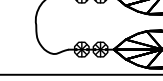
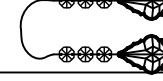
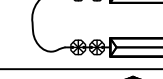
3100D30 D30"H10" L6

part	picture	Description	Parts Number	Qty	Check list
B		1050-14#*4+401-1.5" Steel wire 15.4"		1	
C		1050-14#*4+873-1.5" Steel wire 15.4"		1	
D		1050-14#*2+504-2.5" Steel wire 15.4"		1	
E		1050-14#*2+873-1.5" Steel wire 15.4"		2	
F		1050-14#*4+906-2.5" Steel wire 15.4"		2	
G		1050-14#*4+872-2.5" Steel wire 15.4"		2	
H		1050-14#*4+873-2.5" Steel wire 15.4"		2	
I		1050-14#*2+505-2.5" Steel wire 15.4"		2	
J		1050-14#*2+873-2.5" Steel wire 15.4"		2	
K		1050-14#*3+872-1.5" Steel wire 15.4"		2	
L		1050-14#*2+611-2.5" Steel wire 15.4"		2	
M		1050-14#*3+701-40" Steel wire 15.4"		2	

04

3100D30 D30"H10" L6

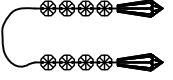
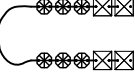
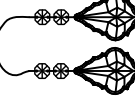
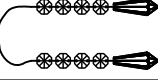
part	picture	Description	Parts Number	Qty	Check list
N		1050-14#*3+401-1.5" Steel wire 15.4"	/	2	
O		1050-14#*3+610-22# +611-22# Steel wire 15.4"		2	
P		1050-14#*2+872-2" Steel wire 15.4"		2	
Q		1050-14#*4+401-1.5" Steel wire 15.4"		2	

3100D30 D30"H10" L6

part	picture	Description	Parts Number	Qty	Check list

Step 2

Canopy installation instructions

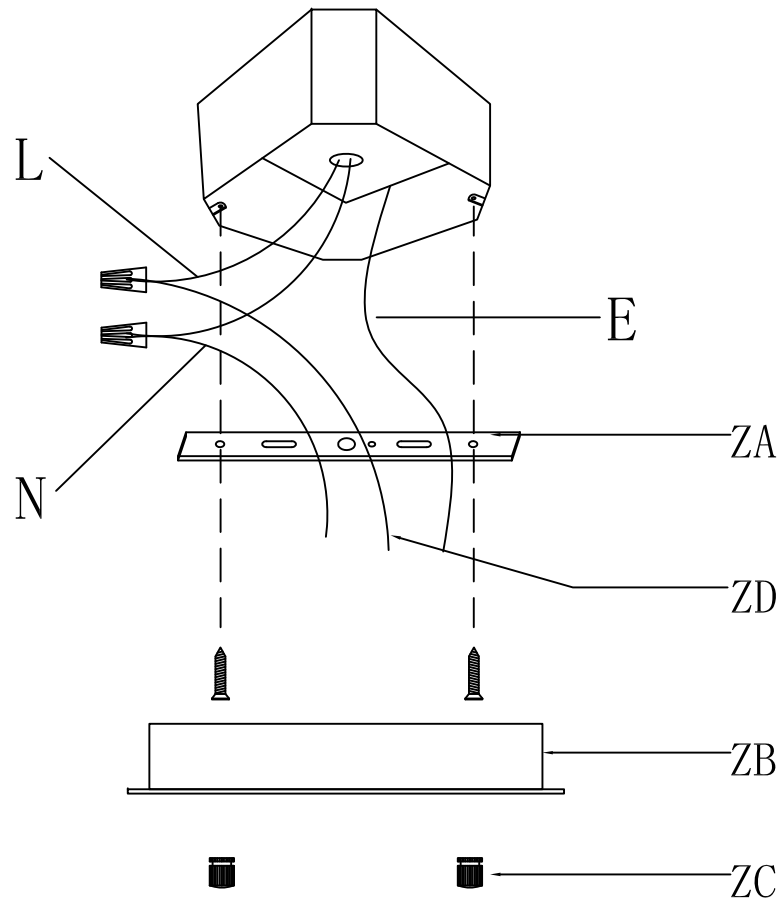

"L" = Hot wire
 "N" = Neutral wire
 "E" = Ground wire

07

Important: This product must be installed in accordance with the local installation codes by a person familiar with construction and operation of this product and the hazards involved.

1. Black wire from ceiling(junction box) attaches to "L" wire from the fixture.
2. White wire from ceiling((junction box) attaches to "N" wire from the fixture.
3. "E" wire from the fixture is attached to the mounting bracket and an additional "E" wire from the mounting bracket must be secured to the junction box.
4. Secure mounting bracket to the junction box.
5. Insert screws in side of top unit the mounting bracket.

08

Frame Assembly Diagram

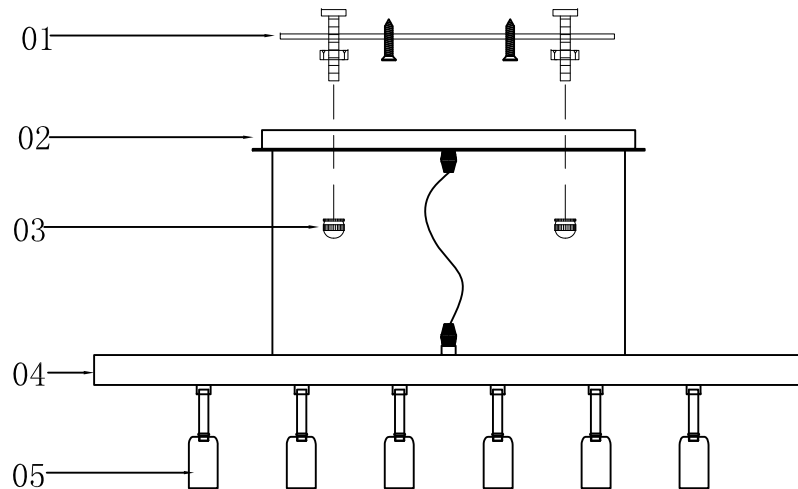

Step 3

Frame Assembly Instructions

Installation:

Please read all instructions carefully.

Before you proceed to install, make sure.

that the power supply is turned off and remains off until installation is complete.

Please note that each part has been assigned a number.

Please proceed in a numerical order.

1. Fix the crossbar (01) on the installation 4" junction-box (J-box).
2. Make sure the positive and negative charges of wire and lamp body match correctly, screw the connect point with the junction cap.
3. Make sure the main wire is enough long and keep the rest wire in the 4" J-box.
4. Fix the lamp body (02) on the crossbar (01) with crossbar bracket (03).
5. As the crystal pressing instruction, hang the crystal parts.

The end!

Step 4 Crystal Dressing Instructions

1. Hang crystal "A", "B", "C", "D", "E", "F", "G", "H", "I", "J", "K", "L", "M", "N", "O", "P", "Q".

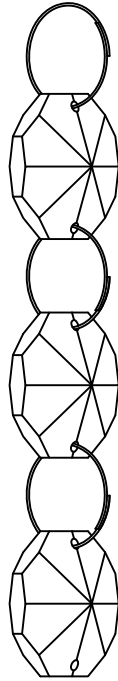

Crystal Detail View

Crystal Dressing Diagram



When dressing the chandelier with the crystals please remember to wear either rubber or cotton gloves. So as to prevent any damage or smudging on the crystals.

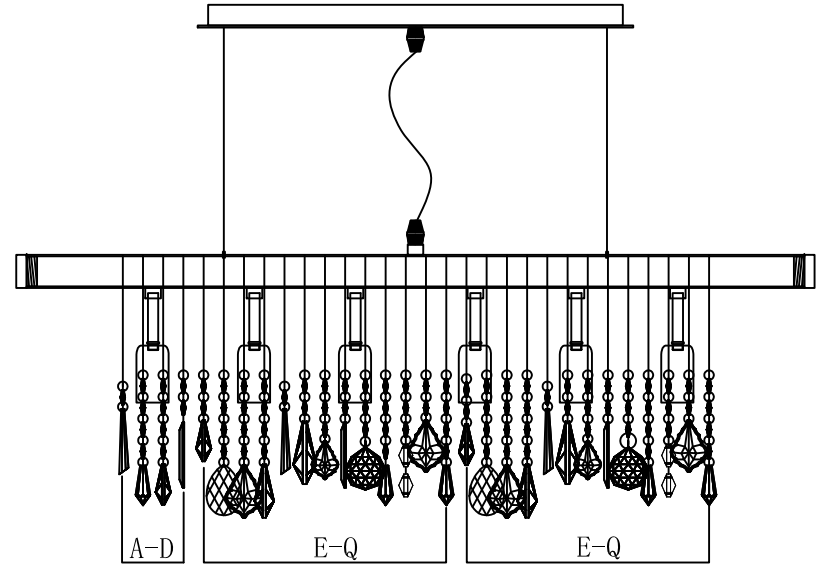

please in order

Congratulations !

You are now done installing your Elegant Lighting fixture. Sit back and admire each crystal as it will become the statement piece for your room/house.

If you require any additional assistance, please contact us at 1-888-388-3390.

Thank you.

Cleaning and Maintenance of Chandelier Frame

The finish on our chandelier frames and fixture frames is protected by a durable coating of lacquer. To clean, use a clean soft, dry cloth. Do not use any metal polishes, cleaners, abrasives or any substance which could remove the protective finish.

Failure to follow these instructions automatically voids the guarantee.

Cleaning and Maintenance of Crystals

Wet a chamois in clean warm water and wipe gently, then polish with a dry chamois.

To Order Crystal Replacement Parts

Should you require replacement crystals or pins (the metal connectors attaching the crystals), contact the store where the product was purchased or contact us at the address shown on the reverse side. For ease of ordering, you may use the original crystal trimming instructions provided with this product and circle the items you wish to order, indicating the quantity by writing the number needed adjacent to the circle and faxing it to our customer service department at 215-423-8882. You will be contacted with prices prior to shipment. All orders must be pre-paid.

Elegant Lighting Warranty

The finish and frame of your new chandelier or fixture warranted for a period of two(2)years from the date of purchase. Our company will, at its option, repair or replace any frame that has a defect in the material or workmanship during the warranty period. All crystals are guaranteed for their original quality during the life of the chandelier. Breakage is not covered by this warranty.

To make a claim under this warranty, contact our customer service department at the address and phone number shown below. A written return authorization form will be sent to you with specific instructions.

CUSTOMER SERVICE DEPARTMENT

500-550 E. Erie Avenue

Philadelphia, PA 19134

Tel: 215-423-8880

Fax: 215-423-8882

Returns and Conditions of Warranty

Returns must be pre-authorized by contacting our customer service department at the address on the reverse side. Returns will only be accepted with a written return merchandise authorization and return shipping charges pre-paid. We reserve the right to inspect all returned merchandise to fully determine the nature of any defect. This guarantee shall not apply to any product that has been changed, altered or otherwise modified, nor shall it apply to any product that has been repaired or altered by anyone other than a pre-authorized facility. We will not be responsible for any breakage or damages incurred during transit, nor for crystal parts or metal frame part that have been subject to misuse, negligence, accident or inappropriate handling. Also, we will not be held responsible for damage incurred during improper installation or wiring by others, nor for damages resulting from a failure to follow the recommended maintenance or installation procedures. This guarantee is issued in lieu of any and all other guaranteed or warranty, whether written or implied and any and all other obligations or liabilities. Further, we neither authorize nor permit any other person or firm to assume for us, any liability in connection with the sale of our products.