

Installation manual for: 2068G43C/EC

Dimensions :D43" H43" L30

Collection : Tiffany

Bulb Type : G9 bulb, include bulb

Total Weight : 55.1 LBS

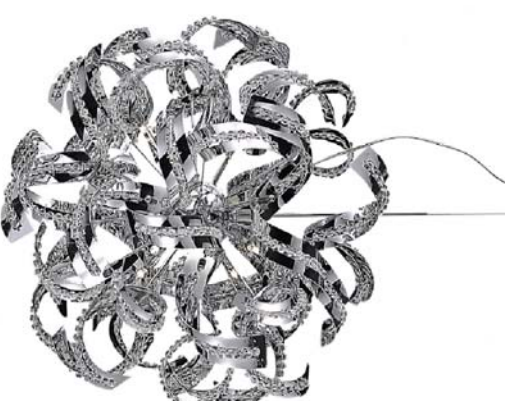

Thank you for choosing our exquisite products. We are providing the finest quality crystal chandelier for our customers. Our master designers and craftsmen intend to give a professional insight on lighting design and product quality. Prompt and efficient services are our priority. We enclosed detailed instructions on how to install your light fixture properly. Please read all instructions carefully and thoroughly. If you have any questions, our professional customer service team is committed to assisting you, please call our toll free HOTLINE AT:

1-888-388-3390



SAFETY

Warning: MAKE SURE THE ELECTRICITY TO THE WIRES YOU ARE

WORKING ON IS SHUT OFF. BY EITHER REMOVING THE FUSE OR TURNING OFF THE CIRCUIT BREAKER.

CAUTION

- Before assembling the lighting fixture, please read all instructions carefully.
- All frame & crystal components are fragile, please handle with care.
- Required supply circuit : 110 - 130V/60Hz
- Labeled wires are“L”for live wire,“N”for neutral wire,“E”for GND.
- Never install fixture on damp ceiling, the room should be dry and well ventilated.
- All electrical components must be installed by a licensed electrician and in accordance with the National Electrical Code and the appropriate local electrical codes.

Unpack the Package

Please open the box carefully and check all the items are inside the box. If you have any installation, assembling and missing parts questions, please call our Customer Service department at 1-888-388-3390. Please have model number(at the front page), where you purchase from and any other relevant information ready, our customer service team will provide comprehensive and worry free service to our valued customers.

01

Returns and Conditions of Warranty

Returns must be pre-authorized by contacting our customer service department at the address on the reverse side. Returns will only be accepted with a written return merchandise authorization and return shipping charges pre-paid. We reserve the right to inspect all returned merchandise to fully determine the nature of any defect. This guarantee shall not apply to any product that has been changed, altered or otherwise modified, nor shall it apply to any product that has been repaired or altered by anyone other than a pre-authorized facility. We will not be responsible for any breakage or damages incurred during transit, nor for crystal parts or metal frame part that have been subject to misuse, negligence, accident or inappropriate handling. Also, we will not be held responsible for damage incurred during improper installation or wiring by others, nor for damages resulting from a failure to follow the recommended maintenance or installation procedures. This guarantee is issued in lieu of any and all other guaranteed or warrantee, whether written or implied and any and all other obligations or liabilities. Further, we neither authorize nor permit any other person or firm to assume for us, any liability in connection with the sale of our products.

02

Elegant Lighting Warranty

The finish and frame of your new chandelier or fixture are warranted for a period of two (2) years from the date of purchase. Our company will, at its option, repair or replace any frame that has a defect in the materials or workmanship during the warranty period. All crystals are guaranteed for their original quality during the life of the chandelier. Breakage is not covered by this warranty.

To make a claim under this warranty, contact our customer service department at the address and phone number shown below. A written return authorization form will be sent to you with specific instructions.

CUSTOMER SERVICE DEPARTMENT

















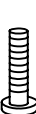











500-550 E. Erie Avenue
Philadelphia, PA 19134
Tel : 215-423-8880
Fax : 215-423-8882

03

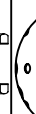
Step 1

Please use the parts list to ensure you are not missing any parts.

2068G43

part	picture	Description	Qty	Check list
ZA		Electrical box(not include)	1	
ZB		GND	1	
ZC		Junction Caps	3	
ZD(P01)		Mounting bracket (ø4")	1	
ZE(P09)		Canopy(ø4.7"H1", Chrome)	1	
ZF(P11)		Knurled nut	85	
ZG		Mounting bracket screws	2	
P01		Mounting bracket (ø4")	1	
P02		Flange bolt (M4*L1.4")	4	
P03		Ground screw	1	
P04		Cable buckle	1	
P05		M12 Hex nut	5	
P06		M12 Lock washer	1	
P07		M12 Rubber gasket	4	
P08		M12 Nipple (L1")	1	
P09		Canopy(ø4.7"H1", Chrome)	1	
P10		Round stainless steel plate(ø5.9"x70.03", Chrome)	1	
P11		Knurled nut	85	
P12		Quick link	2	
P13		Clear Round Electrical Wire(18#,L138",Clear)	1	
P14		Loop	2	
P15		M12 Nipple (L1.6")	1	
P16		Metal ball body	1	
P17		M10 Hickey	1	
P18		Clear Round Electrical Wire(18#,L10",Clear)	5	
P19		Heat shrink tubing	10	
P20		Junction caps	10	
P21		Cable tie	3	

04

Part	Picture	Description	Qty	Check list
P22		M10 Nipple (L5.9")	1	
P23		ø7.1" Metal ball body	1	
P24		G9 Bulb	30	
P25		G9 Socket	30	
P26		L10" White fabric tube	30	
P27		Socket cover (ø0.9"H1.7", Chrome, Iron)	30	
P28		GND	1	
P29		Both end thread pipe (M10*L6.7")	30	
P30		M10 Hex nut	31	
P31		M10 Lock washer	29	
P32		Both end thread pipe(M4*L15.7")	81	
P33		Plastic washer	162	
P34		Steel ribbon	81	
P35		Allen key	1	
P36		M4 Nipple	30	
P37		Coupling	30	

05

Frame Assembly Diagram

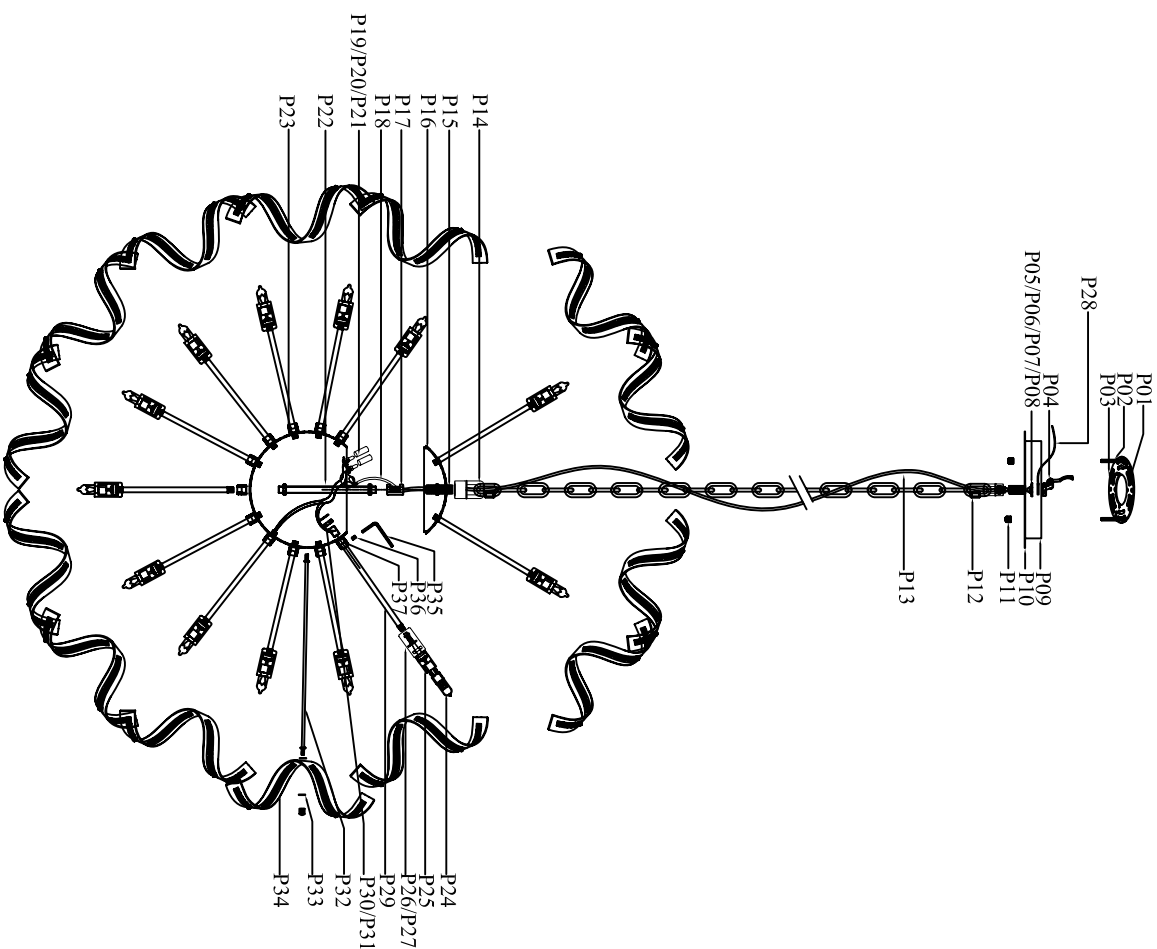

06

Cleaning and Maintenance of Chandelier Frame

The finish on our chandelier frames and fixture frames is protected by a durable coating of lacquer. To clean, use a clean soft, dry cloth. Do not use any metal polishes, cleaners, abrasives or any substance which could remove the protective finish.

Failure to follow these instructions automatically voids the guarantee.

Cleaning and Maintenance of Crystals

Wet a soft cotton fabric in clean warm water and wipe gently, then polish with a dry soft cotton fabric.

To Order Crystal Replacement Parts

Should you require replacement crystals or pins (the metal connectors attaching the crystals), contact the store where the product was purchased or contact us at the address shown on the reverse side. For ease of ordering, you may use the original crystal trimming instructions provided with this product and circle the items you wish to order, indicating the quantity by writing the number needed adjacent to the circle and faxing it to our customer service department at 215-423-8882. You will be contacted with prices prior to shipment. All orders must be pre-paid.

07

Congratulations !

You are now done installing your Elegant Lighting fixture. Sit back and admire each crystal as it will become the statement piece for your room/house.

If you require any additional assistance, please contact us at 1-888-388-3390.

Thank you.

08

Step 2

IMPORTANT: Test sockets with bulb before dressing the fixture.

1. Attach the Mounting bracket(ZD) to the electrical box(ZA).
2. Pull wires up through the Junction Caps(ZC).
3. Attach the Canopy(ZE) to the ceiling panel.
4. Make the electrical connections as detailed in the drawing above.

Canopy Installation Instruction

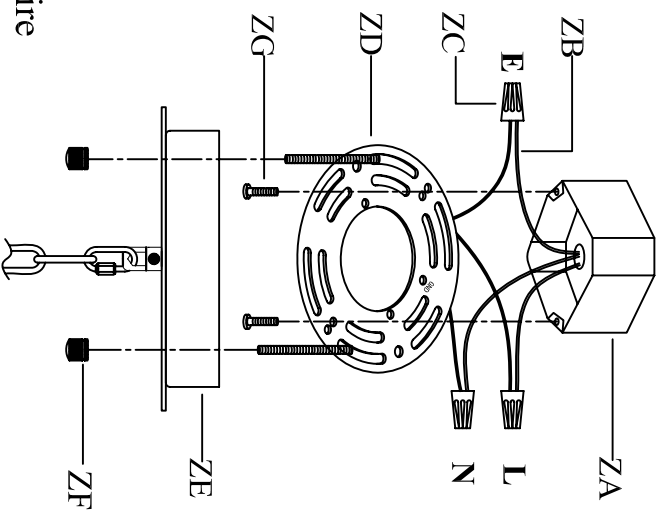

"L" = Hot wire
 "N" = Neutral wire
 "E" = GND

09

Step 3

Frame Assembly Instructions

Installation:

Please read all instructions carefully.

Before you proceed to install, make sure that the power supply is turned off and remains off until installation is complete.

Please note that each part has been assigned a number. Please proceed in a numerical order.

1. Lock Both end thread pipe(07) into Metal ball body, then install Steel ribbon(06), Plastic washer(05), fasten Knurled nut(04).
2. Use Knurled nut(03) to fasten Canopy(01) on Mounting bracket of Ceiling panel.
5. Install G9 Bulb(02).

The end!

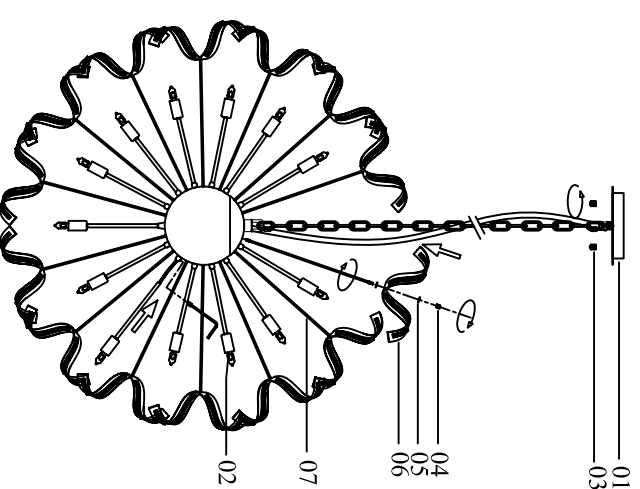
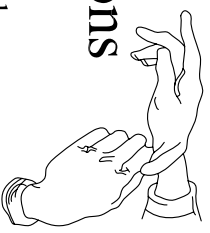

10