



Contemporary Lighting

PRODUCT NAME: LARMES

ITEM NUMBER: E23125-18

Please consult your electrician for hanging fixture and wiring.

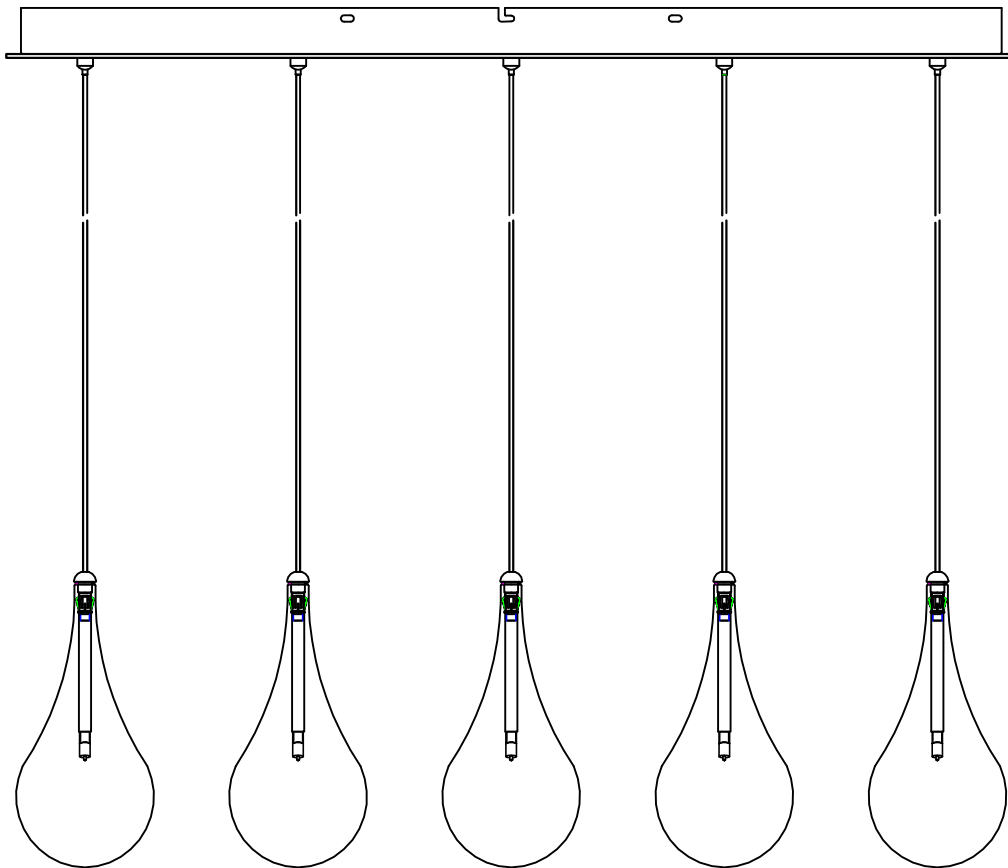

WARNING: Wires need to be connected to driver found in canopy and should not be connected directly to power source or a short may occur

Bulbs (Included): 5 x 1.5W G4 LED

PRODUCTS ARE NOT INTENDED
FOR COMMERCIAL USE.

MADE IN CHINA

Page 1 of (2)

IMPORTANT: Turn off the power at the main fuse or circuit breaker box before starting installation

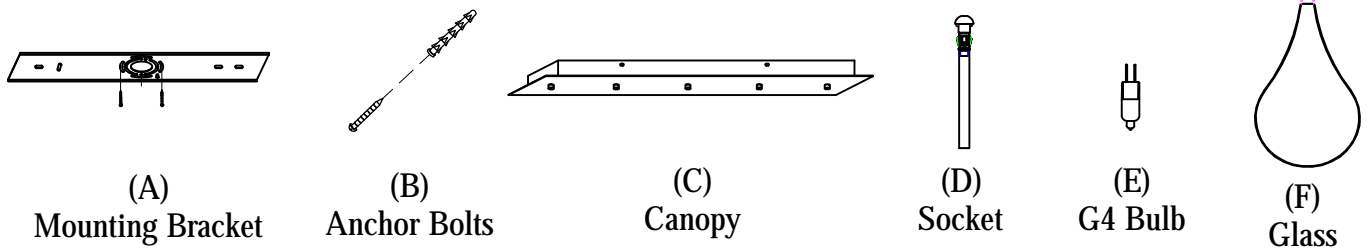

Locate all hardware & components before discarding packaging

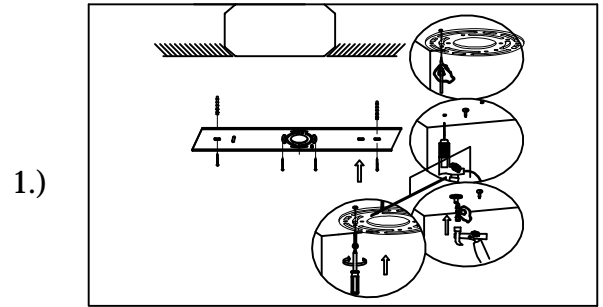
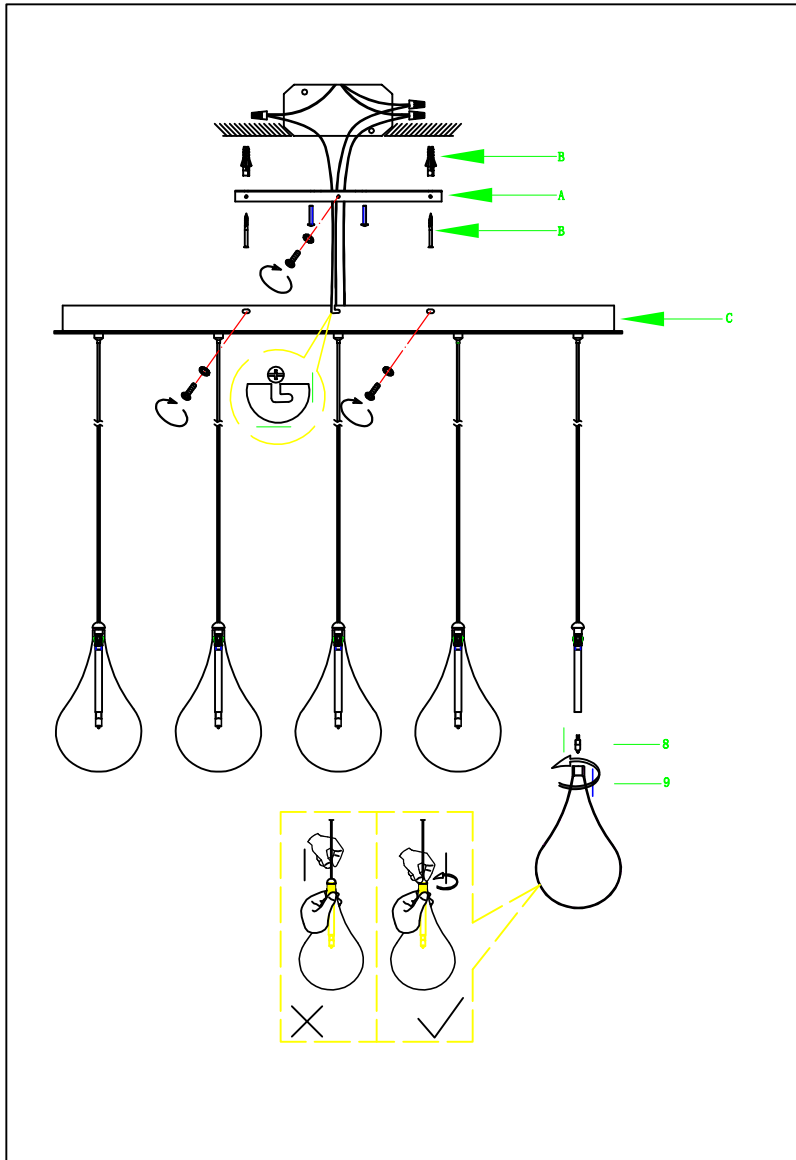

1.) Step.1: Remove mounting bracket (A) and install to electrical box. Mark where anchors meet ceiling, remove mounting bracket from ceiling, and then drill holes using 3/16" drill bit where marked (B). Install mounting bracket and attach anchors to secure bracket at ends.

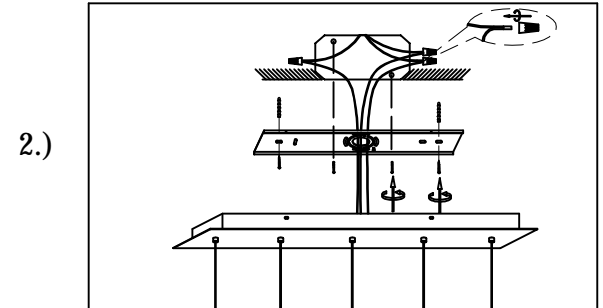

2.) Step.2: Wire fixture to wires in outlet box. Green wire is for Ground.

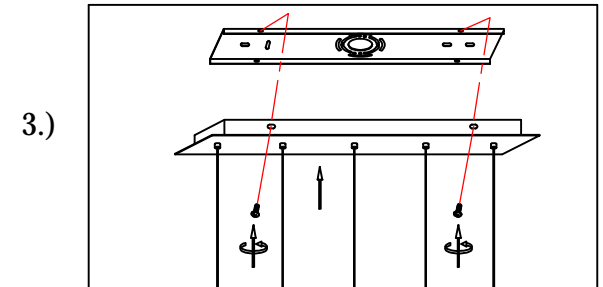

3.) Step.3: Tighten screws on the sides of the canopy (C) to secure the fixture.

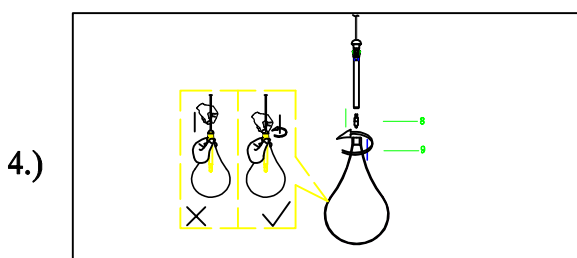

4.) Step.4: Install G4 bulb (E) provided. Gently turn glass (F) onto socket (D) to secure.

Cleaning & Care:

Clean with soft cloth and a mild detergent. Do not use abrasive cleaner.