

GM2600

POST FIXTURE

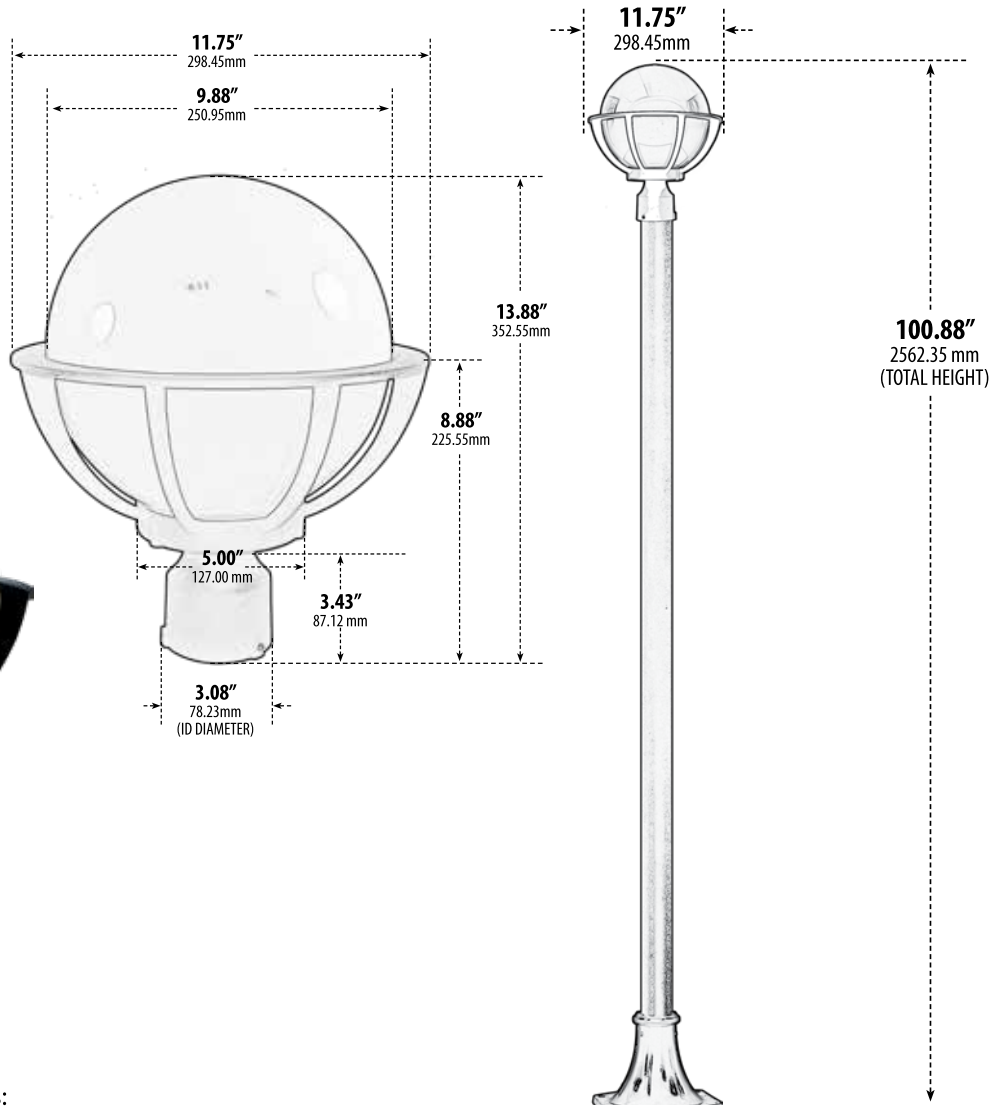

Overall Dimensions:
100.88"H x 11.75"W x 11.75"D

Weight: 21.06 lbs



- ▶ **Material:** Powder Coated Cast Aluminum
- ▶ **Globe:** White, Heat Resistant, Polycarbonate
- ▶ **Available Finish:** Black, Verde Green
- ▶ **ETL Approval Pending**

MODEL NUMBER	LAMP TYPE	ILLUMINANT TYPE	WATTS (W)	VOLTS (V)	LAMP(S) INCLUDED?
GM2600**	A-Type	Incandescent	60	120	NO
GM2600-LED6	A19-LED	FILAMENT LED	6	120	YES
GM2600-LED9	GU24-LED	A19-LED	9	120	YES

**AVAILABLE IN 16W LED Add -LED16 to Model Number

LED Available in Warm or Cool White

DABMAR
LIGHTING

DABMAR LIGHTING INCORPORATED

320 Graves Ave . Oxnard, CA 93030 . 805.604.9090 . f: 805.604.9050 . www.dabmar.com
4693 19th Street Ct E . Bradenton, FL 34203