

# CRYSTORAMA

1958

95 Cantiague Rock Road, Westbury NY 11590  
 ph:516.931.9090 fax:516.931.1254  
 info@crystorama.com www.crystorama.com

## MODEL#: 1542-CH ASSEMBLY AND DRESSING INSTRUCTIONS





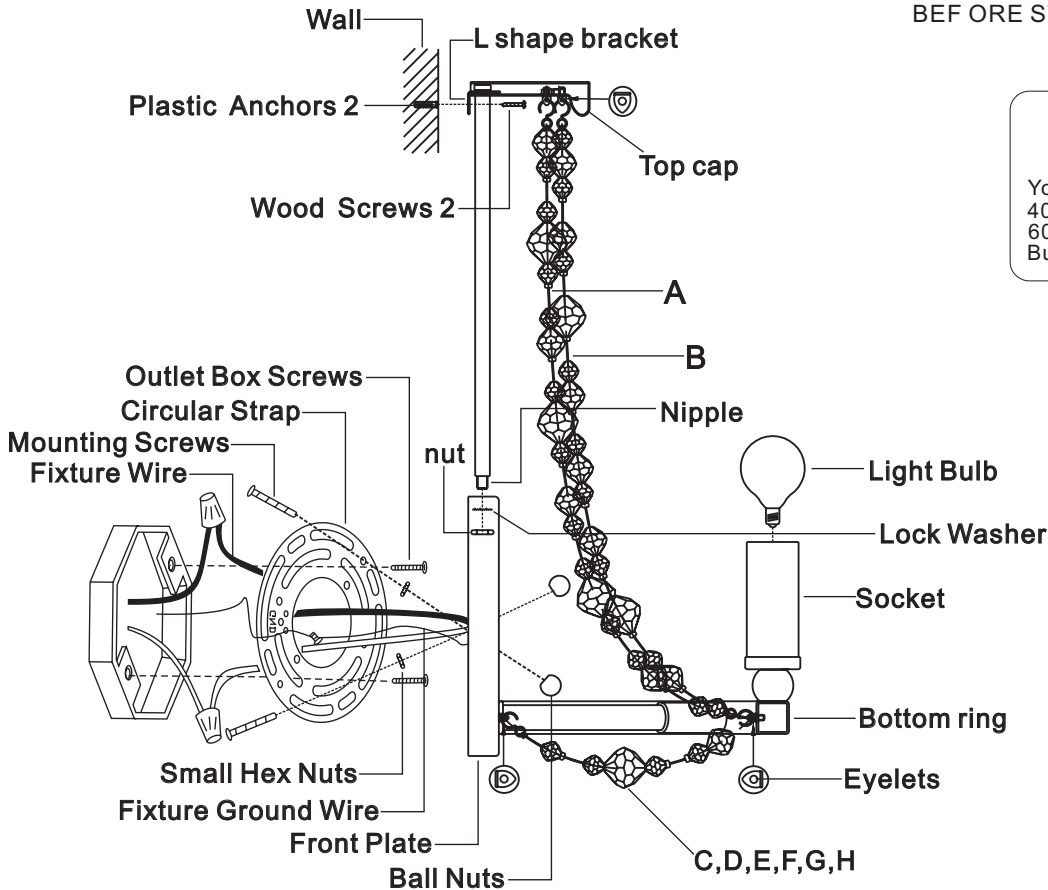

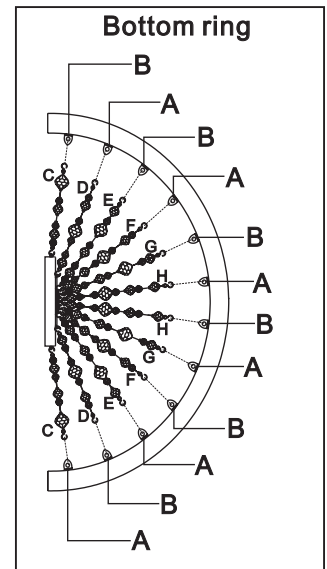
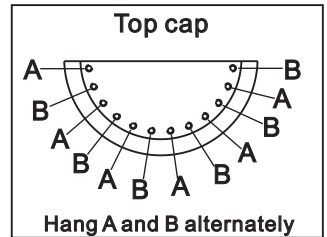

### IMPORTANT

TURN OFF THE POWER AT THE MAIN FUSE OR CIRCUIT BREAKER BOX BEFORE STARTING INSTALLATION



  
 You will need 3-Can. BULB  
 40 watts Recommended  
 60 watts Max  
 Bulb not included



- A =  (GS10mmx4pcs+SS10mmx7pcs+14mmx4pcs+20mmx3pcs)x6pcs
- B =  (GS10mmx4pcs+SS10mmx5pcs+14mmx6pcs+20mmx2pcs)x6pcs
- C =  (GS10mmx1pc+SS10mmx2pcs+14mmx2pcs+20mmx1pc)x2pcs
- D =  (GS10mmx2pcs+SS10mmx2pcs+14mmx2pcs+20mmx1pc)x2pcs
- E =  (GS10mmx2pcs+SS10mmx2pcs+14mmx3pcs+20mmx1pc)x2pcs
- F =  (GS10mmx2pcs+SS10mmx2pcs+14mmx3pcs+20mmx1pc)x2pcs
- G =  (GS10mmx2pcs+SS10mmx2pcs+14mmx3pcs+20mmx1pc)x2pcs
- H =  (GS10mmx2pc+SS10mmx2pcs+14mmx3pcs+20mmx1pc)x2pcs

