

ASSEMBLY INSTRUCTIONS

ITEM NO: BO-3107TB

CAREFULLY UNPACK AND PLACE ALL PARTS ON A SMOOTH SURFACE.

1. SCREW THREADED ROD (B) CLOCKWISE INTO THE SOCKET ASSEMBLY (A) TO TIGHTEN.
2. PUT WASHER (C) ONTO THE THREADED ROD (B).
3. PLACE SHADE (D) OVER THE THREADED ROD (B), THEN TIGHTEN FINIAL (E) SECURING THE SHADE IN PLACE.
4. INSTALL BULB (NOT INCLUDED) INTO THE SOCKET.
5. INSERT THE POWER PLUG INTO AN OUTLET AND ENJOY !!

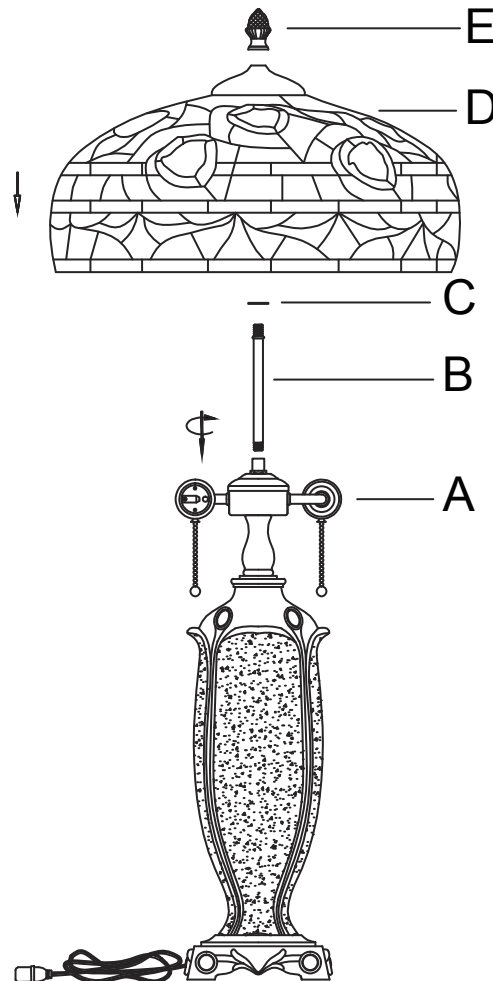

Use MAX 2x60 Wattage type A bulb (Bulb not included)

IMPORTANT SAFETY INSTRUCTIONS:

THIS PORTABLE LAMP HAS A POLARIZED PLUG (ONE BLADE IS WIDER THAN THE OTHER) AS A FEATURE TO REDUCE THE RISK OF ELECTRIC SHOCK. THIS PLUG WILL FIT IN A POLARIZED OUTLET ONLY ONE WAY. IF IT DOES NOT FIT FULLY IN THE OUTLET, REVERSE THE PLUG. IF IT STILL DOES NOT FIT, CONTACT A QUALIFIED ELECTRICIAN. NEVER USE WITH AN EXTENSION CORD UNLESS THE PLUG CAN BE FULLY INSERTED. DO NOT ALTER THE PLUG.

SAVE THESE INSTRUCTIONS FOR FUTURE REFERENCE.