

ASSEMBLY INSTRUCTIONS

ITEM NO:BO-3013TB

CAREFULLY UNPACK AND PLACE ALL PARTS ON A SMOOTH SURFACE.

1.SCREW THE THREADED ROD (D) INTO LAMP BODY SECTION (E).
PUT WASHER (C) INTO THE THREADED ROD (D) .
PUT THE SHADE (B) OVER THREADED ROD (D).
THEN TIGHTEN FINIAL (A) SECURING THE SHADE IN PLACE .

2.INSTALL BULB (NOT INCLUDED) INTO THE SOCKET.

3.INSERT THE POWER PLUG INTO AN OUTLET AND ENJOY !!

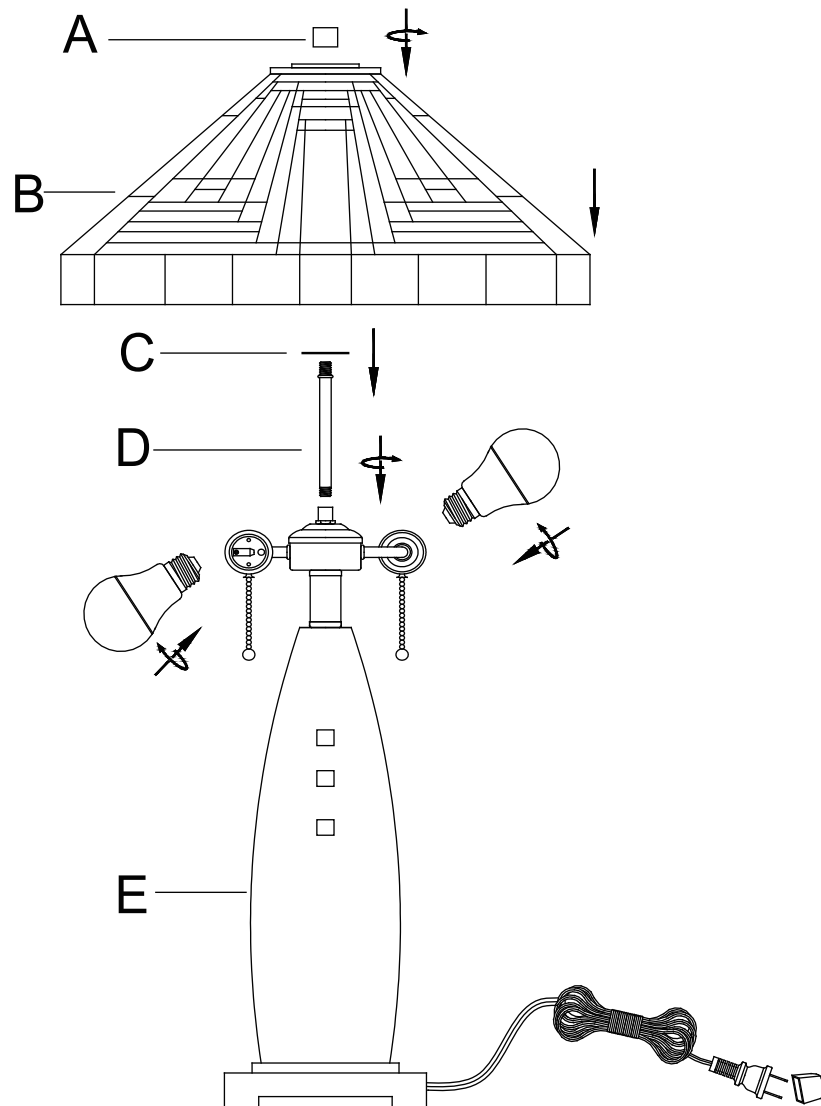

Use MAX 2 x 60 Wattage type A bulb (bulb not included)

IMPORTANT SAFETY INSTRUCTIONS:

THIS PORTABLE LAMP HAS A POLARIZED PLUG (ONE BLADE IS WIDER THAN THE OTHER) AS A FEATURE TO REDUCE THE RISK OF ELECTRIC SHOCK. THIS PLUG WILL FIT IN A POLARIZED OUTLET ONLY ONE WAY. IF IT DOES NOT FIT FULLY IN THE OUTLET, REVERSE THE PLUG. IF IT STILL DOES NOT FIT, CONTACT A QUALIFIED ELECTRICIAN. NEVER USE WITH AN EXTENSION CORD UNLESS THE PLUG CAN BE FULLY INSERTED. DO NOT ALTER THE PLUG.

SAVE THESE INSTRUCTIONS FOR FUTURE REFERENCE.