

1222

INSTALLATION INSTRUCTIONS

Please read carefully and save these instructions, as you may need them at a later date.

CAUTION

WARNING: Risk of Fire. Consult a qualified electrician to ensure correct branch circuit conductor. Min 90°C supply conductors.

Turn off the main power at the circuit breaker before installing the fixture, in order to prevent possible shock.

GENERAL

All electrical connections must be in accordance with local and National Electrical Code (N.E.C.) standards. If you are unfamiliar with proper electrical wiring connections obtain the services of a qualified electrician.

Remove the fixture and the mounting package from the box and make sure that no parts are missing by referencing the illustrations on the installation instructions.

ASSEMBLY AND INSTALLATION

1. Secure the Mounting Bar(9) to the Outlet Box(1) with Mounting Screws (7).
2. Pull out the outlet wire and ground wire from the Outlet Box(1).Make wire connections
--Ribbed/White wire (w/o marking) from light to White wire(2) from power source.
--Smooth/Black wire (w/o marking) from light to Black wire(3) from power source.
--Loop the ground wire(4) to mounting bar(9) with a green screw(6).
3. Put the Lamp body(11) onto Mounting Bar (9), then secure with Rubber Rings (10) and Side Screws(8).
4. Install bulb: (bulb not included)
5. Seal the fixture by putting silicone (not included) around the back plate.

INSTALLATION IS NOW COMPLETED

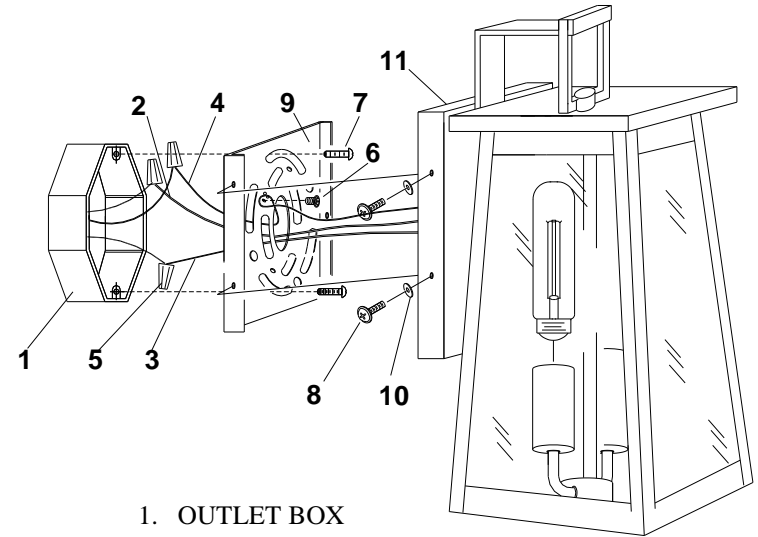

1. OUTLET BOX
2. WHITE WIRE
3. BLACK WIRE
4. GROUND WIRE
5. WIRE CONNECTOR
6. GREEN SCREW
7. MOUNTING SCREWS
8. SIDE SCREWS
9. MOUNTING BAR
10. RUBBER RING
11. LAMP BODY