



# INSTALLATION INSTRUCTIONS

## IMPORTANT SAFETY INSTRUCTIONS

Before assembling your ACCESS LIGHTING fixture, please make sure that you carefully read through this instruction sheet.

CONSULT A QUALIFIED ELECTRICIAN TO ENSURE CORRECT BRANCH CIRCUIT CONDUCTOR.

CONSULTER UN ELECTRICIEN QUALIFIE POUR VOUS ASSURER QUE LES CONDUCTEURS DE LA DERIVATION SONT ADEQUATS

THIS PRODUCT MUST BE INSTALLED IN ACCORDANCE WITH THE APPLICABLE INSTALLATION CODE BY A PERSON FAMILIAR WITH THE CONSTRUCTION AND OPERATION OF THE PRODUCT AND THE HAZARDS INVOLVED.

CE PRODUIT DOIT ETRE INSTALLE SELON LE CODE D'INSTALLATION PERTINENT, PAR UNE PERSONNE QUI CONNAIT BIEN LE PRODUIT ET SON FONCTIONNEMENT AINSI QUE LES RISQUES INHERENTS

**NOTE:** The important safeguards and instructions that appear in this manual are not meant to cover all possible conditions and situations that may occur. It must be understood that common sense, caution and care, are factors that can't be built into any product. These factors must be supplied by the person(s) caring for and operating the fixture. SAVE THESE INSTRUCTIONS AND REFER TO THEM WHEN ADDITIONS TO OR CHANGES IN THE FIXTURE CONFIGURATION ARE MADE.

Read all instructions

Do not install this fixture in hazardous locations

Do not install any fixture assembly closer than 6 inches from any curtain or similar combustible material

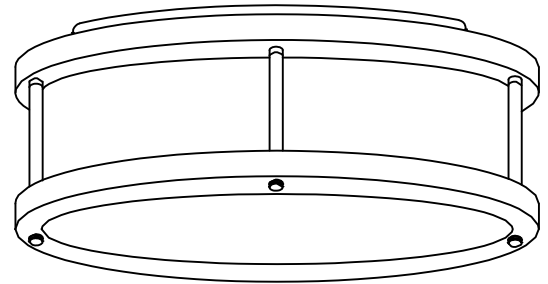

### COLLECTION

CONGA

### APPLICATION

Flush Mount

### MODEL NO.

50080LEDD

### WHAT WE PROVIDE

- Mounting Hardware
- Crossbar
- 1 x Glass Shade
- LED Module

### WHAT YOU NEED

- Screwdriver
- Wire Cutters
- Wiring Supplies as Specified by Electrical Code

## GENERAL INFORMATION

All electrical connections must be in accordance with all ordinances, Local and National Electrical Codes. These fixtures are intended for mounting to a standard 4" x 2 1/2" metal octagon outlet box. The box must be directly supported by the building structure and U.L. Recognized.

## STEP BY STEP INSTRUCTIONS

Before starting your installation disconnect the Power by turning off the Circuit Breaker or by removing the fuse at the fuse box. Just turning the light off at the light switch is not sufficient to prevent electrical shock.



1

### PREPARE FIXTURE

If there is an existing fixture remove it.  
Expose the supply wires from the J-box.  
Secure the crossbar to the J-box with the supplied screws.  
Ensure that the additional screws face downward.

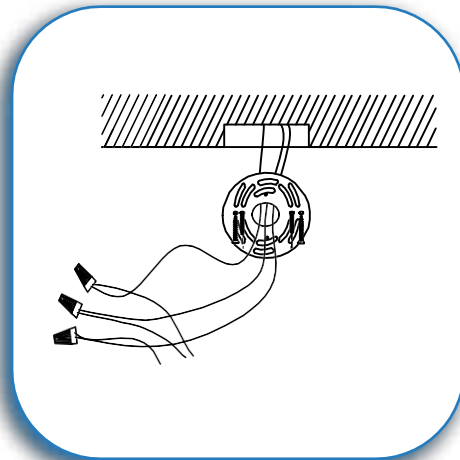

2

### CONNECT THE WIRES

Gently pull the supply wires through the hole in the crossbar. Connect the black supply wire to the black fixture wire. Secure with the supplied wire nuts.  
Connect the white supply wire to the white fixture wire. Secure with the supplied wire nuts. Either wrap the green wire around one of the protruding screws or connect it to the supply ground wire. Secure all wires with U.L. Certified electrical tape (not supplied).  
Tuck all wires carefully into the J-Box.

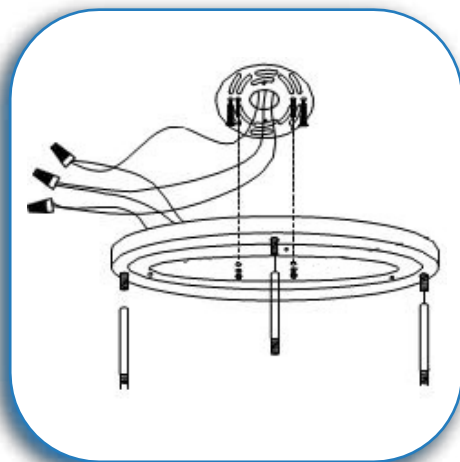

3

### MOUNT THE CANOPY

Fit the fixture canopy up to the crossbar. Insert the hanging screws into the designated holes in the canopy.  
Secure with the supplied thumb screws.  
Tighten 3pcs threaded rods to the canopy.

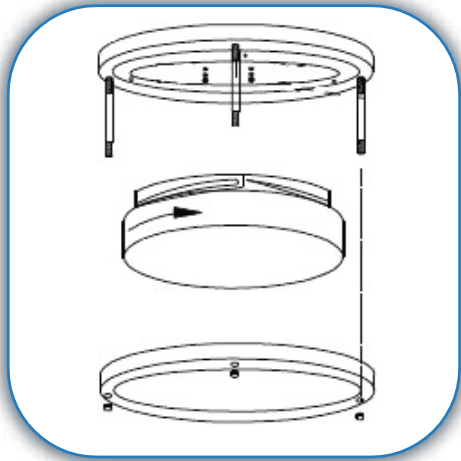

4

**SECURE GLASS SHADE AND FRAME**

Hold the glass shade up to the canopy. Rotate the glass and ensure the glass shade is secured to the canopy.

Cover the metal frame and align the hole with the threaded rods and secure with the supplied nuts.

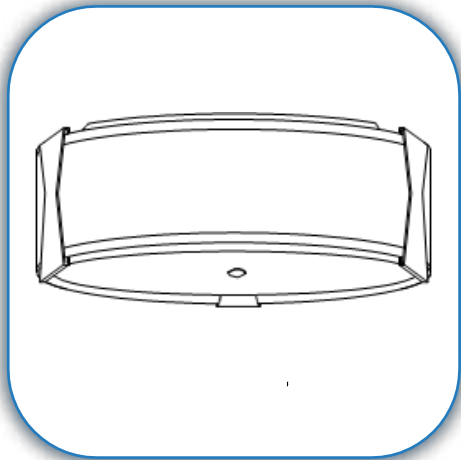

5

**RESTORE THE ELECTRICITY AND CHECK THE OPERATION OF YOUR NEW ACCESS LIGHTING FIXTURE**

