



Assembly and Installation Instructions for Model's

30086FM

CAUTION - RISK OF FIRE

Warning please make sure the electrical breaker is shut off before commencing with this installation

Installation of this fixture should be done by a licensed electrician or by a person familiar with local electrical codes and the construction and operation of this fixture.

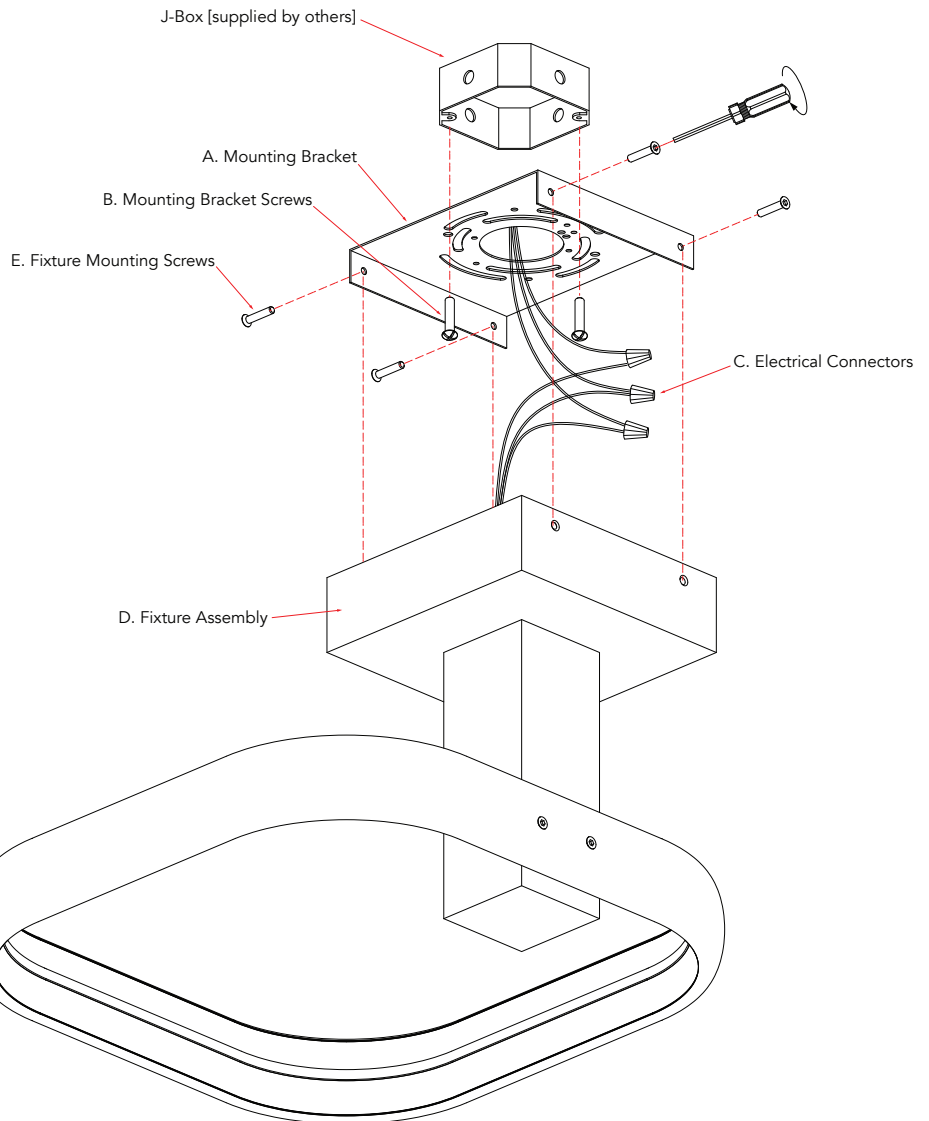

Package Contents		
Part	Description	Qty
A	Mounting bracket	1
B	Mounting bracket screws	2
C	Electrical connectors	3
D	Fixture assembly	1
E	Fixture mounting screws	4

Installing the fixture

please ensure the electrical breaker is in the Off position before commencing

- 1 Attach the Mounting bracket (**A**) to the Junction box [Supplied by others] using the Mounting bracket screws (**B**).
- 2 Connect the supply wires to the fixture wires using the supplied electrical wire connectors (**C**). White supply wire to the White fixture wire, Black supply wire to Black fixture wire and the ground Bare Copper or Green wire to the Green fixture wire. Once the electrical wire connectors are securely fastened it is recommended to tape these connectors with electrical tape.
- 3 Secure the Fixture assembly (**D**) to the Mounting bracket (**A**) using the Fixture mounting screws (**E**).
- 4 Switch on the electrical breaker switch and your new fixture is ready for many years of trouble free use.